

Using GeoGebra to Enhance Student Understanding of Phasor Diagrams in AC Circuits Courses

Dr. Siddharth Vyas, California Polytechnic State University - San Luis Obispo

Siddharth Vyas is a full-time lecturer of Electrical Engineering at the California Polytechnic State University, San Luis Obispo. He teaches graduate and undergraduate courses in circuits and electronics. He received a Bachelor of Engineering degree in Electronics and Instrumentation at the Medicaps Institute of Technology and Management, Indore, India, and an MS in Electrical Engineering (Electrophysics) and a Ph.D. in Electrical Engineering at Drexel University, Philadelphia. His research interests include applications of magnetic particles in medicine and biology, engineering education, and diversity in engineering education.

Prof. Ali Dehghan-Banadaki, California Polytechnic State Uni.

Dr. Ali O. Shaban, California Polytechnic State University, San Luis Obispo

Professor Shaban received his Ph.D. degree in Electrical Engineering from Oregon State University in 1985. He joined the Electrical Engineering Department at Cal Poly in 1984. Since 1985, Dr. Shaban has done consulting work with San Diego Gas & Electric, Chevron, Southern California Edison, JPL Scientific, and Bluepoint Associates, Ltd., in San Luis Obispo. Dr. Shaban's field of interest is electric machines, power quality, power systems analysis, and power systems protection. He has published in the areas of synchronous machines, induction motor, reliability, and power quality. He is a senior member of the IEEE and PES.

Using GeoGebra to Enhance Student Understanding of Phasor Diagrams in AC Circuits Courses

Siddharth Vyas, Ali Dehghan Banadaki, and Ali O. Shaban

Electrical Engineering Department, California Polytechnic State University, San Luis Obispo.

Introduction

Understanding, drawing, and interpreting phasor diagrams is an essential skill for electrical and mechanical engineers. Phasor diagrams are an important graphical tool that can be used to easily solve AC circuits that could sometimes be rather difficult to solve using mathematical equations. However, undergraduate electrical and mechanical engineering students continue to struggle with the concepts of phasor diagrams largely because of a lack of an easy to use and freely available drawing tool. Recently, Agrawal et. al developed a phasor toolbox for AC circuit analysis using Matlab^[1], however, not all students have access to Matlab as it is a paid software. Traditional lectures on phasor diagrams have relied on the use of pencil, eraser, graph paper, ruler, compass, and protractor. In addition to being difficult to use, the combined use of these tools is rapidly getting obsolete in the modern engineering world where simulation environments have almost entirely replaced the physical drawing tools. This paper presents the use of GeoGebra an easy to use and freely available online drawing tool to teach phasor diagrams to undergraduate electrical and mechanical engineering students. The use of GeoGebra in teaching Statics and Mechanics course topics has been published and appreciated^[2, 3]. This paper will present the use of GeoGebra in drawing phasor diagrams of AC circuits containing resistors, capacitors, and inductors. A distinct and important advantage of the use of GeoGebra in drawing phasor diagrams over hand-drawn phasor diagrams is that GeoGebra allows the student to manipulate the phasor diagrams to test their conceptual understanding.

GeoGebra vs Traditional Tools for Phasor Diagrams

Engineering higher education has seen several changes in the last decade. One such change has been an increasing use of simulation environments based on but not limited to Matlab^[1], LabVIEW^[4], Excel macros^[5], Javascript^[6, 7], GeoGebra^[2, 3] etc. in classrooms and laboratories to aid active-learning. Active learning has been widely associated with enhancement of student learning, however, in order to achieve full potential of active learning tools, it is very important that the tools be freely available, well-structured, and intuitive. GeoGebra developed by Markus Hohenwarter is one such open-source mathematical simulation environment intended for learning and teaching mathematics and science from primary school to university level. According to the information available on GeoGebra website, it has been used by over a 100 million students.

This paper presents an exploratory effort in utilizing GeoGebra in class and in laboratories as an active strategy for teaching phasor diagrams to electrical and mechanical engineering students. Visualizing the behavior of AC circuits using phasor diagrams can be an invaluable tool for students understanding of AC circuits. Typical circuit analysis textbooks often start with

introductory explanation of phasor diagrams using series circuits with two passive circuit elements (a resistor and a capacitor or a resistor and an inductor). This initial development and analysis of phasor diagrams quickly moves to more complex circuits with more complicated phasor diagrams. It has been observed that students get lost during this transition from drawing phasor diagrams for simpler circuits to drawing phasor diagrams for more complex circuits. Drawing accurate phasor diagrams is critical to obtaining accurate measurements of voltages, currents, and phase angles between various currents and voltages in a circuit.

The process of drawing phasor diagrams using traditional tools of compass, ruler, protractor, and a graph paper requires that the user first select a scale, for example, 1 cm = 1 volt, and then proceed to draw the phasor diagram. The selection of the scale is paramount to the accuracy of the phasor diagram and is primarily dependent on the physical size of the graph paper and the resolution present in the graph paper. The choice of a poor scale can cause the phasor diagram to move out of the physical graph paper and may require the user to rethink the scale, this whole process of deciding the scale can be rather cumbersome and often leads to frustration. The GeoGebra simulation environment has an infinite area for drawing the phasor diagrams, in addition it also allows the user to zoom in and zoom out of the graph paper for various observations and measurements.

We presented the following question to 20 students during our EE 242 Electric Circuit Analysis II Laboratory course offered during Winter 2019 quarter at the California Polytechnic State University, San Luis Obispo, and the student response suggests that most students consider GeoGebra to be superior over traditional tools in drawing phasor diagrams. Three students chose not to answer the question.

Question: If you have used both GeoGebra and Traditional Tools to draw phasor diagrams:	
Select one:	Number of students with each response
GeoGebra is superior to Traditional Tools	13
Traditional Tools are superior to GeoGebra	1
Both are equally good	3
Total number of responses:	17

The GeoGebra instructions for drawing phasor diagrams presented in this paper can be utilized for drawing phasor diagrams for many kinds of circuits, however, this paper will focus on a series circuit where an AC source is in series with a resistor, an inductor, and a capacitor.

Introduction to GeoGebra Workspace

GeoGebra is a dynamic mathematics software that combines geometry, algebra, and calculus. Even though the software has many functionalities, we only require the *Geometry* application available within GeoGebra. The *Geometry* application has all the necessary tools required to successfully draw a phasor diagram. The *Geometry* application can be accessed via this link: <https://www.geogebra.org/geometry>. This link directly brings the user to the *Geometry* workspace where the user can start to draw. The work space of *Geometry* is shown in Figure 1.

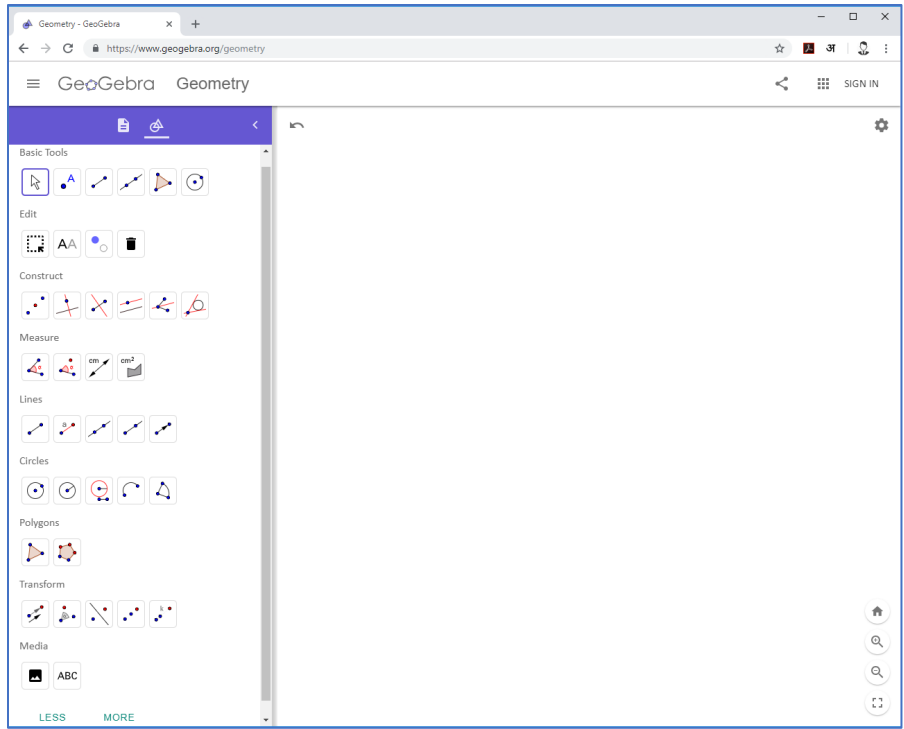

Fig. 1. Workspace of the *Geometry* application of GeoGebra

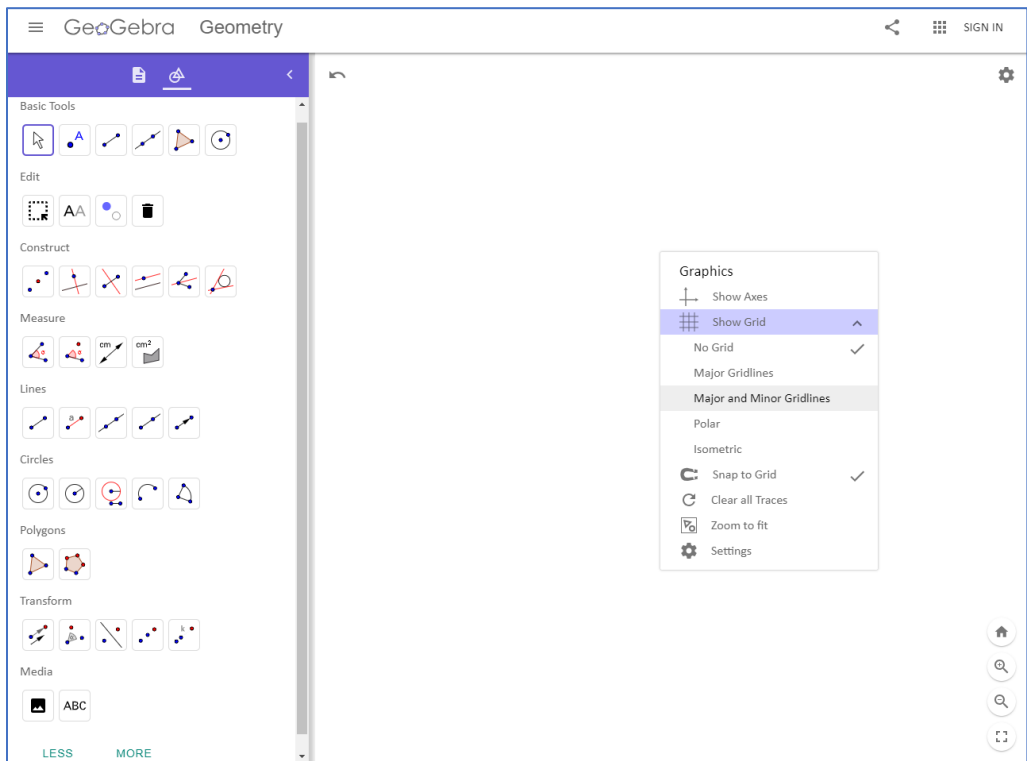

Figure 2. Obtaining Gridlines in the Workspace

Major and minor gridlines can be introduced into the workspace by right-clicking anywhere in the workspace and selecting *Major and Minor Gridlines*. The presence of major and minor gridlines makes it easier to draw perpendicular lines that may be needed in some of the phasor diagrams. The axes can be introduced in a similar manner by right-clicking anywhere in the workspace and selecting *Show Axes*. See Figure 2.

The menu on the left of the workspace has several items, however, the user needs only some of those items in order to draw the phasor diagram. We will now go over all these items one by one:

Circles (circle with center and radius): This item allows the user to draw a circle with a user-defined radius anywhere in the workspace. The user can select the position of the center of the circle in the workspace by left clicking at the position of interest in the workspace. The left click opens a popup window that allows the user to specify the radius of the circle. Once a radius is entered in the popup window, *Geometry* draws the circle with the specified center and radius.

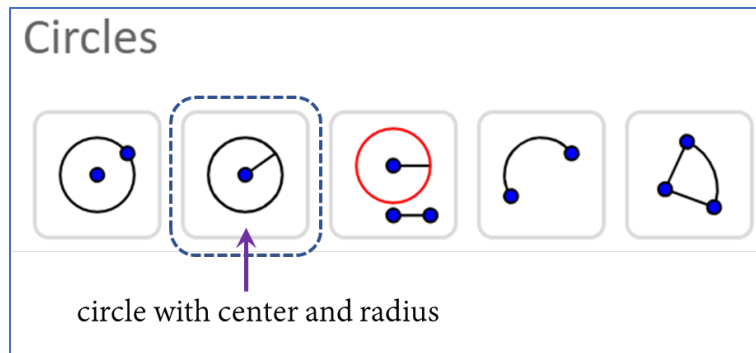

Fig. 3. GeoGebra's *Geometry* Item: Circle with Center and Radius

Lines (Segment with Given Length): This item allows the user to draw a horizontal line-segment with a user-defined length. The user can select one end of the line-segment by left clicking at the position of interest in the workspace. The left click also opens a popup window that allows the user to specify the length of the line-segment. Once the length of the line-segment is entered in the popup window, *Geometry* draws a horizontal line-segment. The horizontal line-segment can be turned into a vertical line-segment by left clicking and dragging one of the ends of the line-segment.

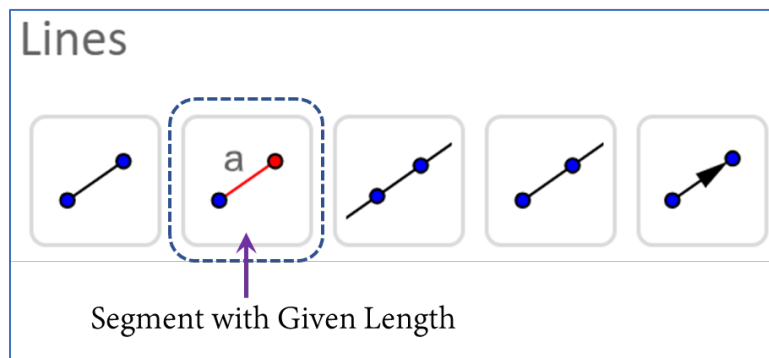

Fig. 4. GeoGebra's *Geometry* Item: Segment with Given Length

Lines (Vector): This item allows the user to draw a vector between any two points in the workspace. Once the vector is drawn, the user can right click the vector to display the horizontal and vertical components of the vector.



Fig. 5. GeoGebra's *Geometry* Item: Vector

Measure (Angle): This item allows the user to measure the angle between two lines. The user shall left click the two lines one by one to measure the angle between them.

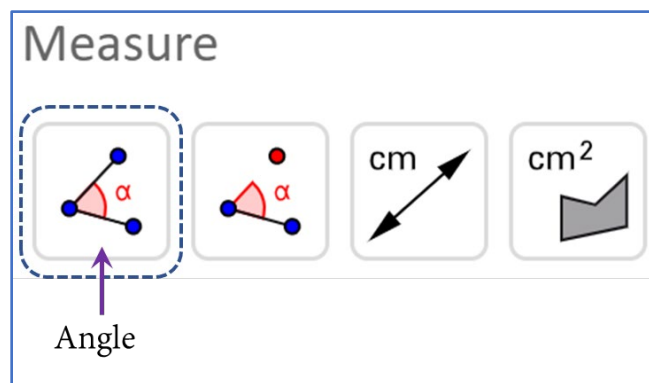

Fig. 6. GeoGebra's *Geometry* Item: Angle

Basic (Move): This item allows the user to drag and move the workspace. The user can left click to select this item and then left click and hold to drag the workspace.



Fig. 7. GeoGebra's *Geometry* Item: Move

Edit (Select Objects): This item allows the user to select items present in the workspace. Once an item is selected in the workspace, the user can right click the item to observe and/or modify its properties or the user can press the delete key to delete the item.

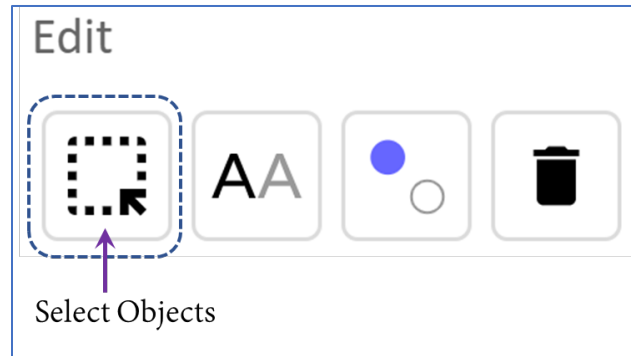

Fig. 8. GeoGebra's *Geometry* Item: Select Objects

Steps to Drawing the Phasor Diagram for a Series RLC Circuit

In the Electric Circuit Analysis III Laboratory course taught at the Electrical Engineering Department at California Polytechnic State University – San Luis Obispo, laboratory experiment # 4 requires students to complete a prelab portion consisting of accurately drawing a phasor diagram for a series RLC circuit with a practical inductor. This prelab exercise allows the students to get some practice with drawing phasor diagram and determining the unknown quantities for the given circuit. During the laboratory experiment students measure voltages across all components in a similar series RLC circuit and then draw the phasor diagram to obtain the resistance of the practical inductor and phase angles between voltages.

Figure 9(a) shows a simple AC circuit with series RLC components, the circuit is operating in steady-state at constant frequency. L and R_L are lumped parameters representing quantities that are distributed throughout the entire length of the coil. The Kirchhoff's Voltage Law for the circuit may be described by drawing a phasor diagram to show both magnitude and phase angle of the voltages in the circuit. Figure 9(b) illustrates such phasor diagram. Note that circuit current is chosen to be the reference for the phasor diagram since current is common to all components in the circuit. In the lab, the magnitudes of \bar{V}_S , \bar{V}_R , and \bar{V}_C are measurable, but not so for \bar{V}_L and \bar{V}_{RL} . This is where phasor diagrams are useful.

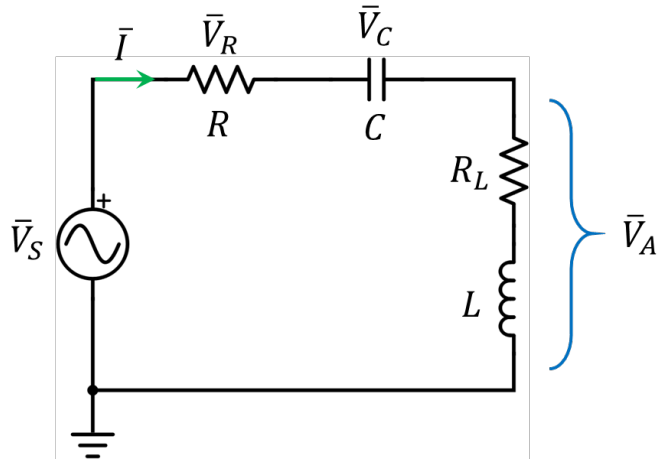

Fig. 9(a). Series RLC Circuit with a Practical Inductor

To determine the magnitudes of \bar{V}_L and \bar{V}_{RL} , it should be noticed first that phasor \bar{V}_R should be in phase with the reference current, while phasor \bar{V}_A has two phasor components: \bar{V}_{RL} which is in phase with the current and \bar{V}_L which leads the current by 90° . To simplify the analysis, the capacitor is assumed to be an ideal element.

Steps to drawing the phasor diagram:

1. Draw horizontal and vertical axes.
2. With origin as the center, draw a circle with radius $|\bar{V}_S|$.
3. With origin as the center, draw a line-segment of length $|\bar{V}_R|$ along the positive horizontal axis.
4. Draw a perpendicular line-segment of length $|\bar{V}_C|$ at the end of line segment $|\bar{V}_R|$ and along the negative vertical axis. This is because the voltage across a capacitor lags the current through the capacitor by 90° .
5. Draw a circle of radius $|\bar{V}_A|$ with the open end of line-segment $|\bar{V}_C|$ as the center of the circle.
6. Find the point of intersection of the two circles.
7. Draw a line-segment connecting this point of intersection of the two circles with the open end of line-segment $|\bar{V}_C|$. The length of this line-segment represents $|\bar{V}_A|$.
8. Now, the horizontal component of phasor \bar{V}_A represents \bar{V}_{RL} while the vertical component of phasor \bar{V}_A represents \bar{V}_L . By KVL, $\bar{V}_A = \bar{V}_{RL} + \bar{V}_L$.
9. The magnitudes of \bar{V}_{RL} , and \bar{V}_L can be measured with a ruler. ϕ and θ can be measured using a protractor or obtained using trigonometry.

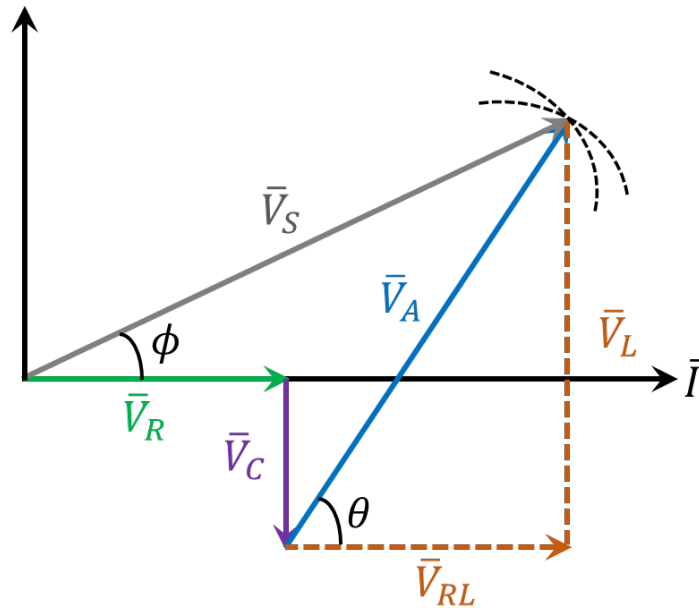

Fig. 9(b). Phasor Diagram for the Series RLC Circuit in fig. 9(a).

The steps described above can be used to draw the phasor diagram either on a physical graph paper or using GeoGebra's Geometry application. We will now describe the steps to drawing the phasor diagram to a series RLC circuit where some of the voltages are known and some are unknown. At the end of drawing the phasor diagram, the user can obtain the values of unknown voltages.

Steps to Drawing the Phasor Diagram for an Example Circuit using GeoGebra

In the circuit diagram shown in fig. 10, the students are required to obtain the values of inductance, the resistance of the inductor, and the phase angle between the source voltage and the total current using phasor diagram.

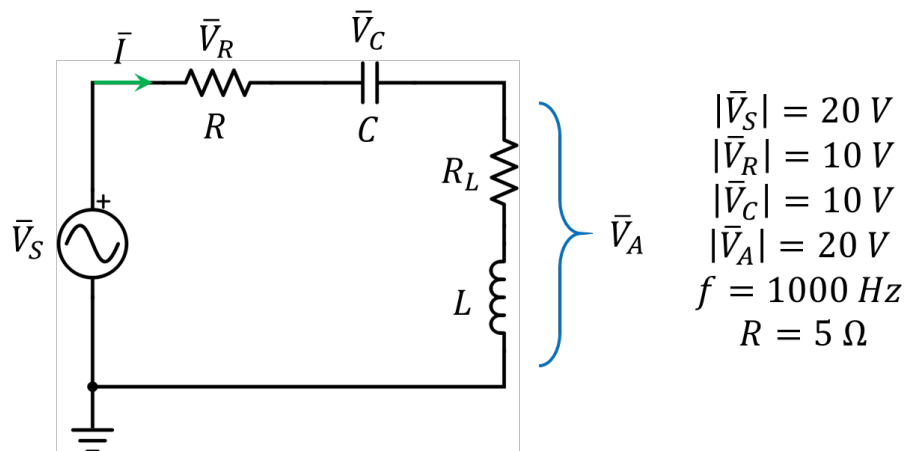

Fig. 10. Series RLC circuit.

We are now going to illustrate the process of drawing the phasor diagram for the series RLC circuit and determining the magnitudes of voltages across L and R_L with the help of that phasor diagram. Consecutively, we will find the values of C , L , and R_L .

Step 1. Draw a circle of radius 20 units to represent $|\bar{V}_S| = 20 V$. See fig. 11(a).

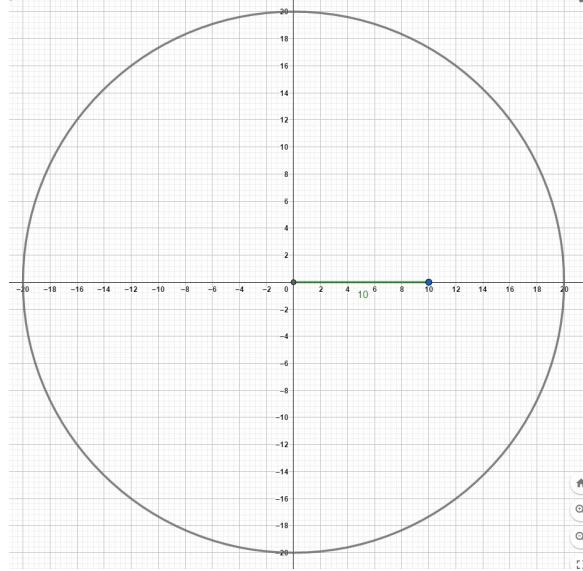
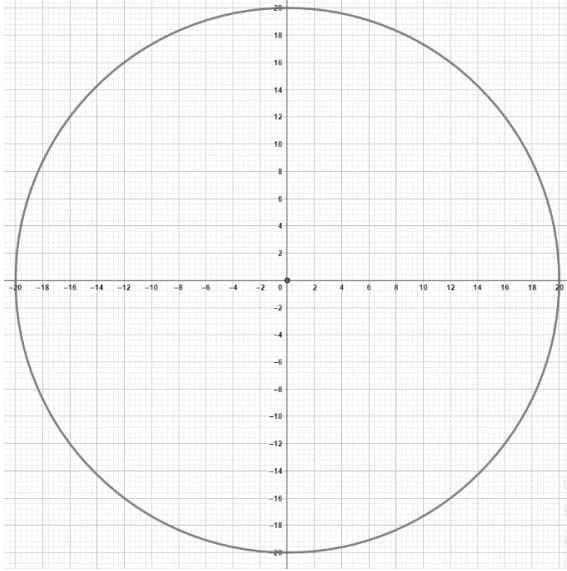

Fig. 11 (a). (Left) Circle of radius 20 units representing $|\bar{V}_S| = 20 V$

Fig. 11 (b). (Right) Line-segment of length 10 units representing $|\bar{V}_R| = 10 V$

Step 2. Draw a line-segment of length 10 units to represent $|\bar{V}_R| = 10 V$. See fig. 11(b).

Step 3. Draw a line-segment of length 10 units perpendicular to $|\bar{V}_R|$ to represent $|\bar{V}_C| = 10 V$. See fig. 11(c).

Step 4. With the open end of line-segment $|\bar{V}_C|$, draw a circle of radius 20 units, this circle will help in determining $|\bar{V}_A|$. See fig. 11(d).

Step 5. Using *Vector*, connect the open end of line-segment $|\bar{V}_C|$ to the point of intersection of the two circles. This vector represents $|\bar{V}_A| = 20 V$. See fig. 11(e) and fig. 11(f).

Step 6. Using *Angle*, measure the angle between the source voltage \bar{V}_S and the total current \bar{I} . See fig. 11(g).

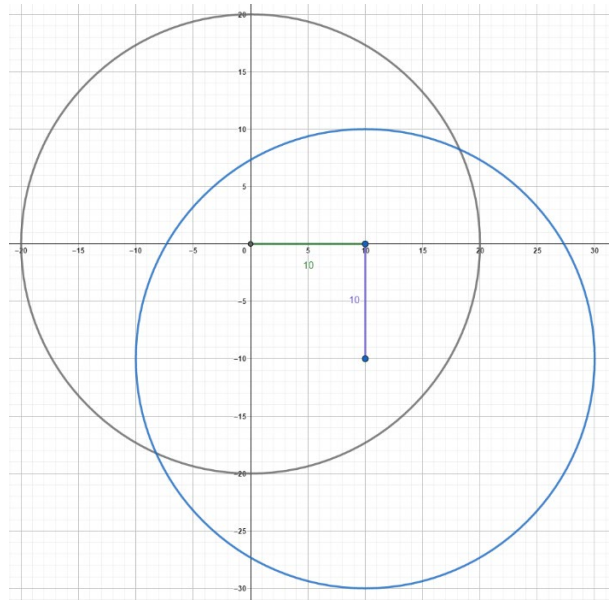
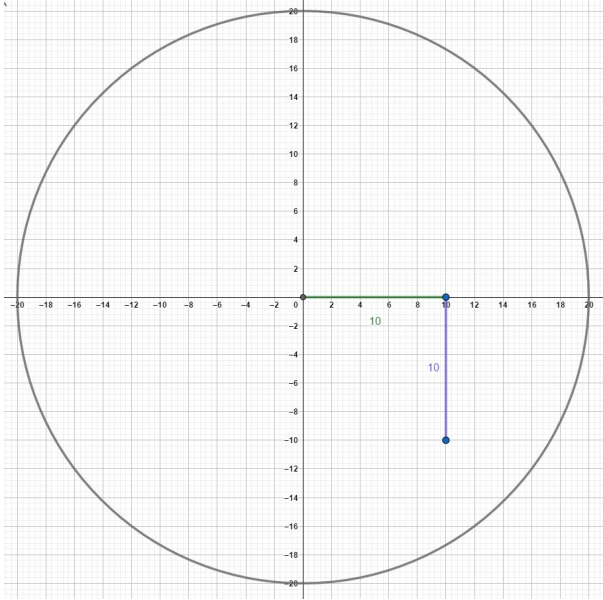

Fig. 11 (c). (Left) Line-segment of length 10 units representing $|\vec{V}_C| = 10 V$

Fig. 11 (d). (Right) Circle of radius 20 units to determine $|\vec{V}_A| = 20 V$

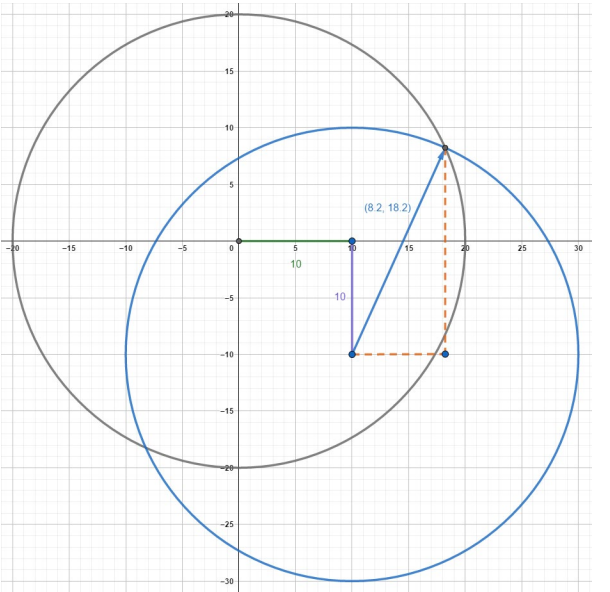
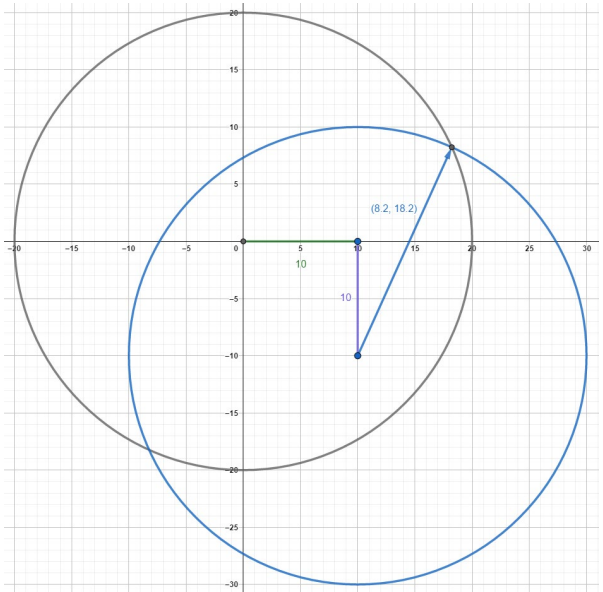

Fig. 11 (e). (Left) Vector representing $|\vec{V}_A| = 10 V$

Fig. 11 (f). (Right) Horizontal and vertical components of vector $|\vec{V}_A|$ representing $|\vec{V}_{RL}| = 8.2 V$, and $|\vec{V}_L| = 18.2 V$

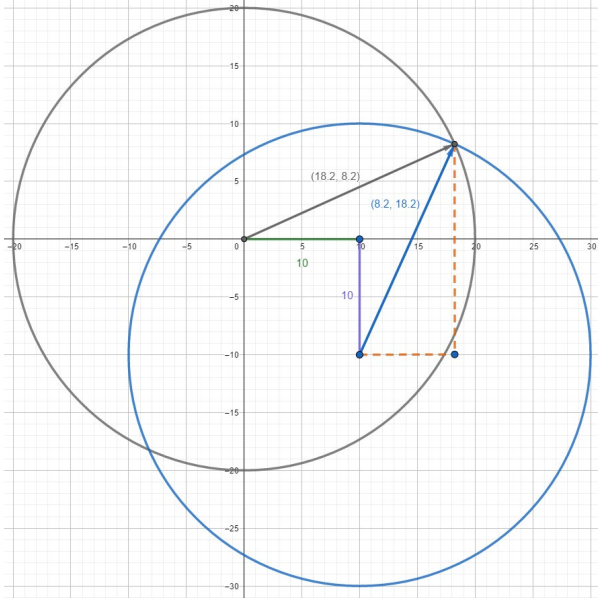

Fig. 11 (g). Horizontal and vertical components of vector $|\bar{V}_S|$ representing $|\bar{V}_{R+RL}| = 18.2 V$, and $|\bar{V}_L - \bar{V}_C| = 8.2 V$

Calculations

The magnitude of the current through the circuit can be obtained as:

$$|\bar{I}| = \frac{|\bar{V}_R|}{|\bar{R}|} = \frac{10}{5} = 2 A$$

The value of inductive reactance can be obtained as:

$$\chi_L = \frac{|\bar{V}_L|}{|\bar{I}|} = \frac{18.2}{2} = 9.1 \Omega$$

The value of inductance can be obtained as:

$$L = \frac{\chi_L}{2\pi f} = \frac{9.1}{2 \times \pi \times 1000} = 1.45 mH$$

The resistance of the inductor reactance can be obtained as:

$$R_L = \frac{|\bar{V}_{RL}|}{|\bar{I}|} = \frac{8.2}{2} = 4.1 \Omega$$

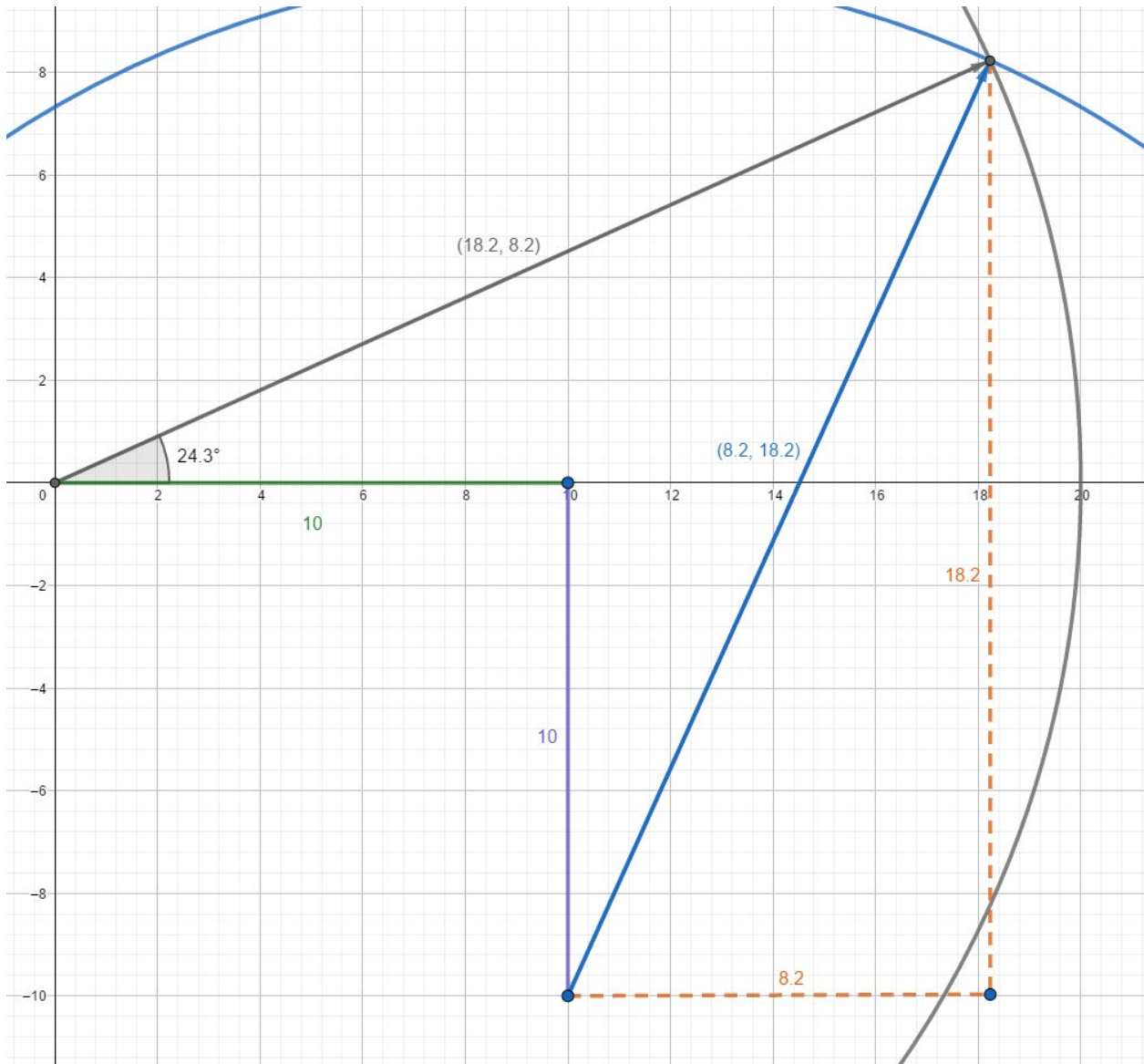

Fig. 11 (h). The complete phasor diagram of the series RLC circuit.

Benefit to the Students

GeoGebra is a free to use online mathematical tool. The students can save their work and revisit it later as per their interest. The students can also download the *Geometry* application of GeoGebra and install it on their computer. As of the date of writing of this paper, GeoGebra can be installed for free on personal computers. In regards to phasor diagrams, students can manipulate the voltage representing line-segments and/or circles and correspondingly observe the change in phase angles between the source voltage and total current thereby determining whether the circuit is essentially capacitive or inductive as a whole. One distinct advantage of GeoGebra is that students can zoom in on any part of the phasor diagram, this allows the students to measure very small angles that might be excruciatingly difficult to measure on a physical graph paper.

Student Feedback

In the Winter 2019 quarter at California Polytechnic State University, San Luis Obispo, EE 242 Electric Circuit Analysis II Laboratory course was offered to students. As part of one of the laboratory experiments of this course, students were required to draw phasor diagrams. The students were free to choose GeoGebra or Traditional Tools to draw the phasor diagrams, however, most of the students chose to draw phasor diagrams using GeoGebra. At the end of the lab a questionnaire was presented to all students. Table 1 provides a summary of the results obtained from the questionnaire. The data obtained suggests that most students appreciate the use of GeoGebra in drawing phasor diagrams.

Table 1. Student Feedback on the Use of GeoGebra

Thinking back to your recent experience with GeoGebra, please indicate your degree of agreement with the following statements:	Strongly Agree	Agree	Neither Agree nor Disagree	Disagree	Strongly Disagree	Total number of Responses
I prefer the use of simulation environment to draw the phasor diagram over traditional tools such as graph paper, pencil, ruler, compass, and protractor.	13	3	1	1	2	20
I liked using GeoGebra software to draw the phasor diagram.	10	7	2	0	1	20
As a first-time user, I found the GeoGebra software easy to use.	5	11	2	1	1	20
The use of GeoGebra software enhanced my understanding of phasor diagrams.	4	12	2	1	0	19
I intend to use GeoGebra in the future to draw phasor diagrams.	9	6	4	0	1	20
I would recommend GeoGebra to other students.	9	7	3	0	1	20

Conclusion

This paper presented an exploratory effort in utilizing GeoGebra to enhance student understanding of phasor diagrams in AC circuits courses. The authors recommend providing a brief introduction and tutorial on GeoGebra before the students begin drawing their phasor diagrams. The authors will continue to use GeoGebra in their future AC Circuits courses to answer some more questions such as, but not limited to:

- Does GeoGebra help students learn specific concepts related to phasor diagrams more readily?
- Do students show greater mastery of phasor diagrams as a result of using GeoGebra?

We hope other instructors will employ GeoGebra, which can be a useful tool in enhancing the student understanding of phasor diagrams.

Bibliography

- [1] J. P. Agrawal, O. Farook, and W. Yu, "Phasor Toolbox for AC Circuit Analysis Using MATLAB.," presented at the ASEE Annual Conference and Exposition, Salt Lake City, UT, June 24-27, 2018, 2018, 23506. [Online]. Available: <https://peer.asee.org/29643>.
- [2] V. Carbonell, C. Romero, E. Martínez, and M. Flórez, "Interactive simulations as teaching tools for engineering mechanics courses," *European Journal of Physics*, vol. 34, no. 4, pp. 991-1004, 2013/05/14 2013, doi: 10.1088/0143-0807/34/4/991.
- [3] D. W. Baker, "The Use of GeoGebra Virtual Interactives in Statics to Increase Conceptual Understanding.," presented at the 2018 ASEE Annual Conference and Exposition, Salt Lake City, UT, June 24-27, 2018, 2018, 22759. [Online]. Available: <https://peer.asee.org/31130>.
- [4] V. Genis, S. Vyas, and J. Milbrandt, "Traditional and Real-time Remote NDT Instruction," *Materials Evaluation*, vol. 68, no. 2, pp. 128-134, February 2010 2010.
- [5] V. Genis and S. Vyas, "Processing of Large Amount of Experimental Data Collected During Laboratory Procedures.," presented at the 2014 ASEE Annual Conference and Exposition, Indianapolis, IN, June 15-18, 2014, 2014, 8659. [Online]. Available: <https://peer.asee.org/22941>.
- [6] F. DePiero, K. C. McKell, and B. Benson, "CATE: A Circuit Analysis Tool for Education," presented at the 2016 ASEE Annual Conference and Exposition, New Orleans, LA, June 26-29, 2016, 2016, 14852. [Online]. Available: <https://peer.asee.org/26463>.
- [7] A. Bielenberg and E. Cheever, "Web-Based Scripts for Animating System Simulations," presented at the 2011 ASEE Annual Conference and Exposition, Vancouver, BC, June 26 - 29, 2011, 2011. [Online]. Available: <https://peer.asee.org/18412>.