

---

# AC 2011-2530: LAB@HOME: REMOTE LABORATORY EVOLUTION IN THE CLOUD COMPUTING ERA

## **Hamadou Saliah-Hassane, University of Quebec in Montreal**

Professor Saliah-Hassane is a senior researcher at the Inter-university Research Center (LICEF), and member of the Ordre des ingnieurs du Qubec (OIQ); of the IEEE (Member of the Administrative Committee of IEEE Education Society (- 2010), Communication Society and Computer Society); of the American Society for Engineering Education (ASEE). He teaches informatics and computer networks at TI-universit, a Distance Education University of University of Quebec in Montreal (UQAM). Professor Saliah-Hassane has a PhD in Computer Aided Analysis and Design from the Electrical and Computer Engineering at McGill University in Montreal and a Master of Applied Science degree from cole Polytechnique de Montral. Professor Saliah-Hassane research interest is, among other, on Remote Laboratories for Global Engineering Education.

## **Maarouf Saad, Ecole de Technologie Suprieure**

Maarouf Saad received a bachelor and a master degrees in electrical engineering from Ecole Polytechnique of Montreal respectively in 1982 and 1984. In 1988, he received a Ph.D. from McGill University in electrical engineering. He joined Ecole de Technologie Suprieure in 1987 where he is teaching control theory and robotics courses. His research is mainly in nonlinear control and optimization applied to robotics and flight control system.

## **Willie K. Ofori, Pennsylvania State University, Wilkes-Barre Campus**

Dr. Willie K. Ofori is an Associate Professor of Electrical Engineering Technology at Penn State Wilkes-Barre, where he teaches telecommunications, wireless systems, networking, optoelectronics and analog and digital electronics. He is a member of IEEE, IET (England), and a Chartered Engineer (CEng) of England. His research interests include RF components and antennas, and Powerline Communication. He is an advocate of diversity in the educational environment. Dr. Ofori received his Ph.D. from the Electronic Systems Engineering Department at University of Essex in England.

## **karimou djibo, Licef**

Karimou Djibo has his doctorate (Ph.D) in computer science from the University of Picardie Jules Verne and a master's degree in computer networking, University of Reims Champagne Ardenne (France). He worked in many laboratories and research centers. He also taught at several universities and engineering schools. His research interests are networks, mobile networks, sensor networks, network security and systems, distributed systems and remote laboratories.

## **Hassane Alzouma Mayaki, UCAD and LICEF Research Center, Montreal, Canada.**

Hassane ALZOUUMA MAYAKI earns a master degree in Data communications and information security from University Cheikh Anta Diop (UCAD) in Dakar, equally a Professional degree in computer science and another degree in Computer Management. He is currently a Technical Manager at the Digital Campus of the Francophone University Agency (Campus Numrique Francophone) in Niamey. Hassane ALZOUUMA MAYAKI is currently registered as a PhD student at UCAD and LICEF Research Center, Montreal, Canada.

## **Mamane Moustapha Dodo Amadou, cole de technologie suprieure**

Mamane Moustapha, Dodo Amadou received the M.S. degree from the Kharkov Polytechnical Institute, Ukraine, in 1994, and the Ph.D. degree from the same institute in 2001. Since 2003, he is a lecturer for undergraduate students in the department of Electrical Engineering of cole de technologie Suprieure , Quebec, Canada. His research interests are in power systems modeling, simulation, and control, as well as in virtual and remote laboratories.

## **Lab@Home: Remote laboratory evolution in the Cloud Computing Era**

### **Abstract**

The Evolution of Cloud Computing, decreases the cost of electronic components, and the sizes of devices, and makes possible the emergence of other models for exploitation of remote laboratories. Indeed, until now, most remote laboratories are made available by accessing equipment or the real instruments installed in a remote laboratory room through computer networks and software and hardware interfaces. Now, it is time to allow students to carry out laboratory work from home by using relatively inexpensive compact measuring instruments. The proposed environment will be based on the concept of Software as Service to allow the student to use software tools from the Cloud to perform the tasks in solo or in collaboration with other partners. This article will show the various components of the environment of a remote laboratory in Electrical Engineering, and results obtained following the implementation of this new concept which adds more flexibility to the existing ones we have investigated so far.

### **Introduction**

Today, in a world that has become increasingly technological and interconnected, the ability to provide information and educational resources at the right time wherever the location of the learner, has become a major issue for education and research institutions. It is therefore necessary to manage all the constraints to delocalized learners. In this context, distance education is an asset that has already proven itself. Considering engineering education, the constraints are even greater. Learning resources are no longer limited to electronic files or electronic multimedia documents. In many laboratories, students carry out practical work with very expensive equipment. For over a decade, we have proposed and demonstrated the validity of remote laboratories in Electrical Engineering [1], an approach that has since made its way into numerous educational institutions and research centers.

The goal was to create a positive learning environment that allows learners to access, through computer networks, equipment in teaching labs using software interfaces for manipulating real devices via the web [1,2,3]. Self-study mode can be individualized with assistance provided for each learner. These remote laboratories do not yet reflect the model we propose in this article. In this case, the equipment is no longer centralized in a remote laboratory room. The apparatus consist essentially of measuring, analysis, or signal generation instruments. This affordable equipment can be miniaturized and current technology offers networking hardware and software interfaces for which ubiquity is

omnipresent. These instruments are portable, available to learners where they are, and connected to their own computers or to wired or wireless computer networks.

The proposal we make in this article eliminates the need for educational and research institutions in scientific and technical domain the need for acquisition of facilities and local laboratories to host, manage and maintain servers. Investment can therefore be made for development of computer applications for operating remote laboratories. Our proposal, as discussed in the sections that follow, is to make optimal use of virtualization and distributed access to applications that Cloud Computing [4] allows us to. This will be done with materials that are lightweight, compact and portable, and less expensive. The purpose is to create learning environments that enlarge the concept of remote laboratories that are currently available both in terms of technology infrastructure and pedagogy.

### **Global description of Lab@Home setting**

Lab@home is mainly composed of two parts: the first represents the cloud area and the second shows the distributed user stations over computer networks at several sites. In some cases laboratory devices are hooked on to the computer. For our experiments, the users are at three different sites and they collaborate to complete a lab work. The Cloud provides a networked conferencing environment for the participants through a platform named BigBlueButton designed as a result of a project on an open source software [1]. The software is adapted and deployed on a Virtual PC acting as a server and allows each invited participant to connect and initiate a self or collaborative laboratory session. The following functionalities, similar to those we have designed and implemented in one of our previous real time distributed learning environment [6] are used for our experiments:

1. Application Sharing: the most useful feature that enable a learner to share his/her entire desktop or a windows on his/her networked computer, including his connected light and inexpensive laboratory instruments user interfaces.
2. White board: Used for annotation and drawings during a synchronous session;
3. Private or public chat rooms;
4. Audio and Videoconferences: Participants can share their webcam with others; for example, a student can use this functionality to show his/her device under test, Figure 2 to a lab supervisor or his/her teammates
5. Uploading and presenting documents

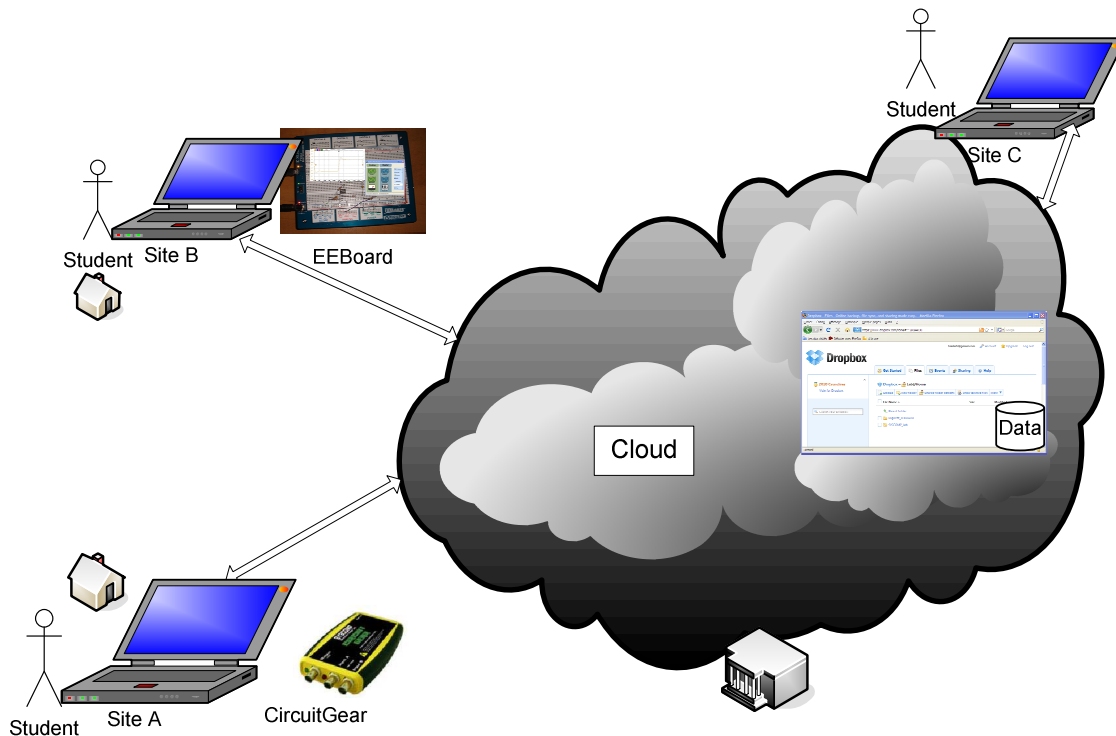

Figure 1 Lab@Home Global Architecture

In its current state, BigBlueButton software cannot store and share data. To validate our Cloud Computing Lab@Home concept to implement a software as service functionality, we have used, along with the BibBlueButton Open Source software [7], a social web software add-on that allows participants of a given learning activity to store and share their files and documents through computer networks. A detailed description of the software and hardware used in our test scenario are the following:

### The Implementation

The Cloud is based on virtualization components [4]. It offers flexibility of resource use and installation of custom applications. The Cloud by his role allows users to connect to Web services without installing or buy special equipment. This new concept of remote laboratory in the Cloud Computing Era, instead of what we and all other involved in research on virtual learning environments are most of the time doing for years[1-3], mainly helps in three ways: a) no or little time and money is spent to set a sophisticated learning management environment; b) no more need to buy and install remote accessible devices in a centralized laboratory and manage their accesses and maintain them; b) The student has now in his/her hands, the laboratory kits to manipulate and the software environment allows the lab tutor to assess remotely his/her progress.

In the implementation of our platform we opt for a private or internal Cloud based in part on a server virtualization conference and secondly, data storage distributed over the Internet. This allows, first, to make independent infrastructure and Web services and other resources to collaborative and virtualized available to stakeholders.

In this section we present the implementation of our collaborative work environment with free software. This implementation involved the installation of certain tools and features as described on our overall architecture. The implementation of the environment involves several steps: a) a first stage which includes the implementation of virtual machines, b) a second step is to install free software on a virtual infrastructure. This step is to configure the virtual infrastructure on the physical and incorporate the necessary software. Then the last phase is to start a conference in the virtual environment created.

### Specifying host machines

For this implementation, a VMware virtual machine has been installed on a Pentium 4 CPU 3.80 GHz with a distribution of Windows XP running with 2 GB of RAM. The operating system installed on the VMware is a distribution of Linux 10.4 with the characteristics of 512 MB of memory and a 40GB capacity (including 8 GB in use). This machine is configured on its network interface bridge in order to assign a public IP address and make it accessible via the Internet.

## Overview of BigBlueButton's Architecture

BigBlueButton, the collaborative conferencing system deployed on the VMware virtual machine is described in detail in [5].

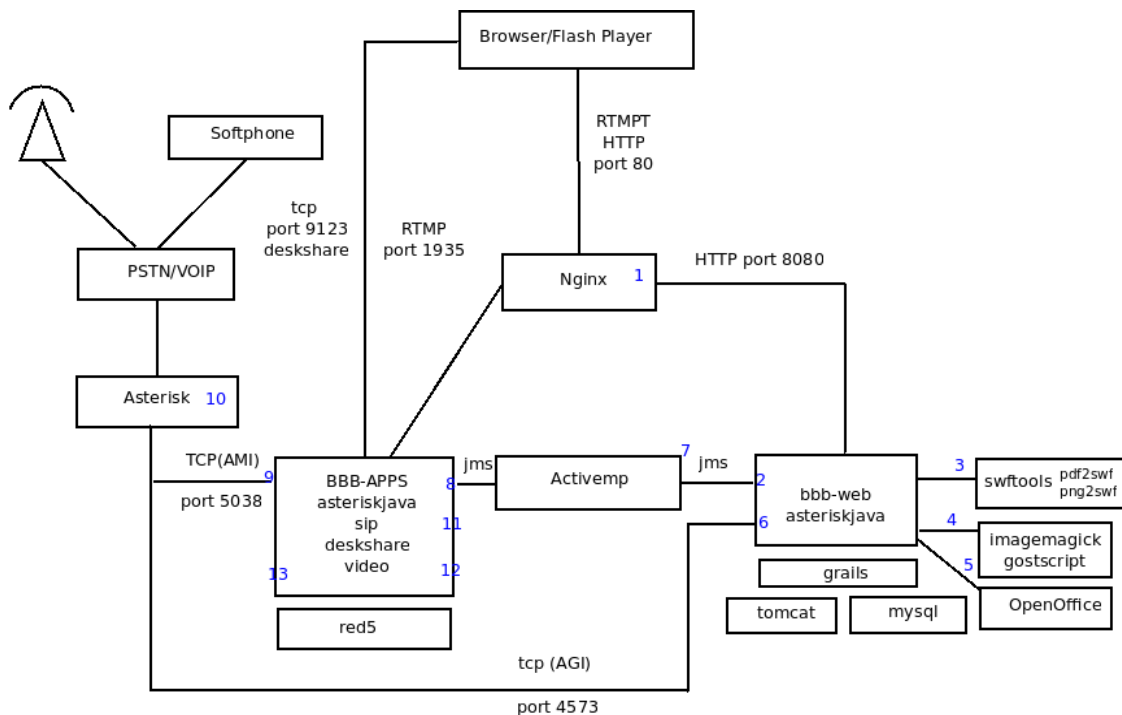

Figure 2 BigBlueButton's Architecture [5]

Table 1: Description of the BigBlueButton's Architecture

<b>1</b>	<i>Nginx (engine x) proxies bbb-web bbb-apps to support RTMPT (RTMP Tunneling) server out the bbb-client</i>
<b>2</b>	<i>Grails application that handles creating conference and scheduling. Also, handles login and logout when joining the conference.</i>
<b>3</b>	<i>Responsible for converting PDF presentation slides to Flash</i>
<b>4</b>	<i>Responsible for converting PDF presentation slides to Flash in case SWFTools is not able to convert. Also, generates the thumbnails.</i>
<b>5</b>	<i>Responsible for converting .doc .ppt &amp; .xls files to PDF presentation slides.</i>
<b>6</b>	<i>The AGI (Asterisk Gateway Interface) queries the database to determine if the dialed in voice conference number is valid or not .</i>
<b>7</b>	<i>Message conduit between bbb-web and bbb-apps</i>
<b>8</b>	<i>Red5 application responsible for synchronizing all the participants in the conference.</i>
<b>9</b>	<i>The AMI (Asterisk Management Interface). Listen for user events (joined/left, mute/unmute, talk) and issues commands (mute/unmute, kick user) to Asterisk.</i>
<b>10</b>	<i>Voice conference server .</i>

### **Files and Documents Sharing**

We use Dropbox software [7], offering a cross-platform support, Figure 3. It permits storing, synchronizing and sharing files over several computers put into play. In our case, it is accessible using any web browser and supports multiple types of operating systems. This interface allows each participant to automatically store, back up and synchronize files on the cloud environment. Also, file versioning is always possible. This is important and is needed to apply an access control and security for each repository. Regardless of its location, each user can work on his hardware independent of the rest of the hardware in the system. Then finally, participants can collaborate to bring together various parts of this work. In the context of our experimentation, we use participants located in three places. To demonstrate this cooperation, we cite the establishment of practical work done in collaboration between users of the site A and B, while the user of Site C is a supervisor during this implementation.

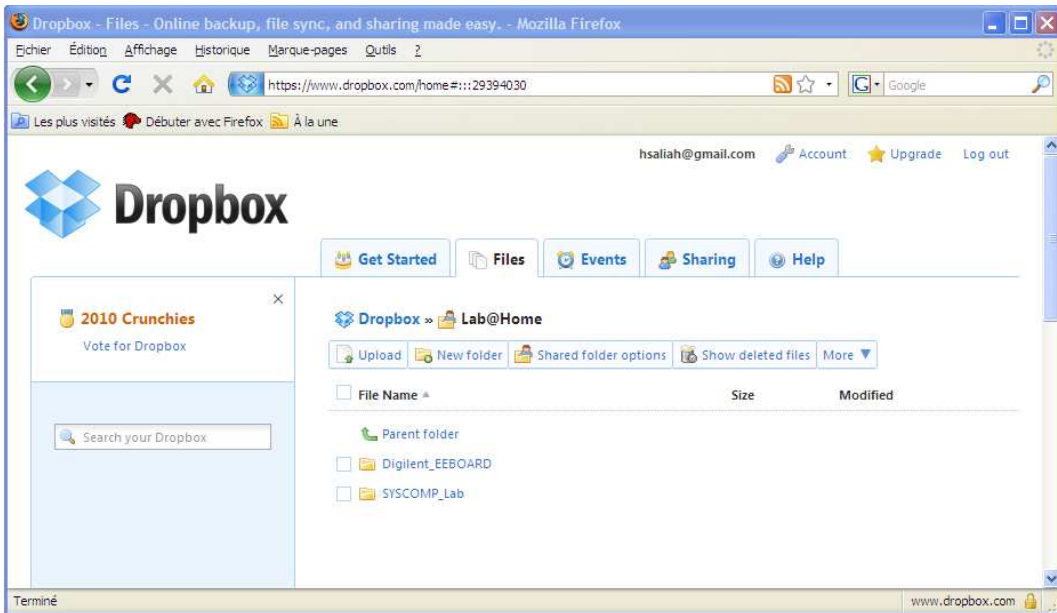

Figure 3 A View of DropBox Web Access Set up for our Experiment

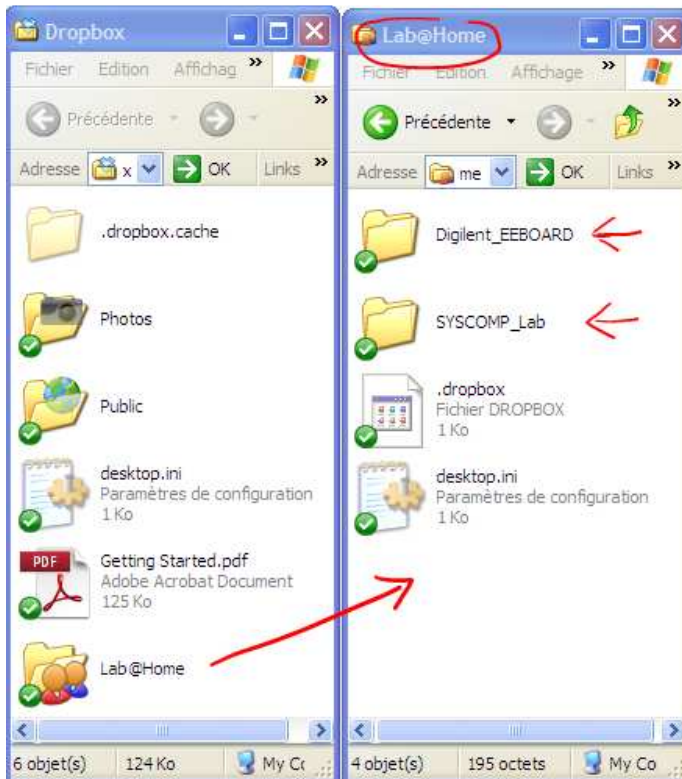

Figure 4 Lab@Home Shared DropBox Folder on a Student Computer

Each invited participant drops his/her files into the Dropbox folder. Any file edited, generated and saved is automatically updated everywhere else. Figure 3 shows a participant Lab@Home folders containing some experiments results, generated with a student software installed on his/her machine and the hardware connected to his/her computer. A teacher or a laboratory supervisor can access the files over the Internet and retrieve them in order to evaluate the work while it is being done or asynchronously. Similarly, a teammate can do so.

### Case study

In order to illustrate how the proposed environment can be used, the transfer function (TF) estimation of a second order circuit is considered. This is one of the six laboratories to be performed by the undergraduate students of the electrical department of the École de technologie supérieure, Montréal, Québec, Canada during the course of *Basic Linear Control Systems*.

The circuit under study is shown in Figure 5.

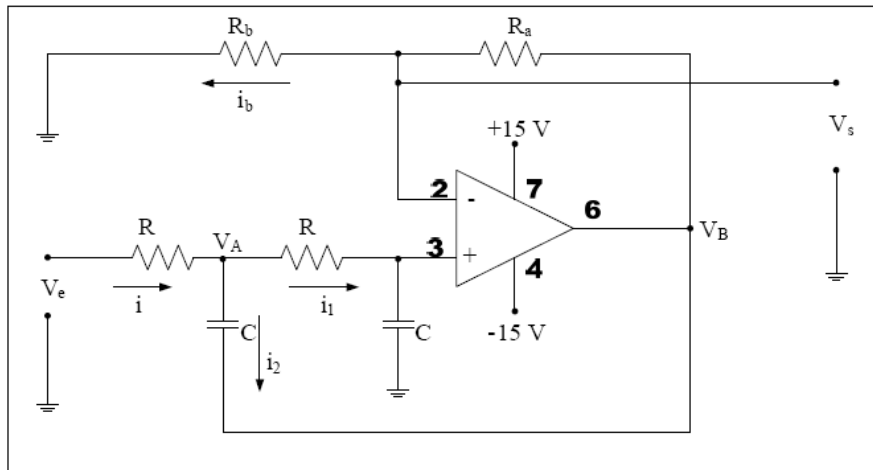

Figure 5 Circuit under study

### Theoretical Review

Following an appropriate network analysis method, it can be concluded that the transfer function of the circuit is expressed as:

$$G(s) = \frac{K\omega_n^2}{s^2 + 2\zeta\omega_n s + \omega_n^2}, \quad (1)$$

where:

$$K = 1, \quad \omega_n = \frac{1}{RC}, \text{ and} \quad \zeta = \frac{2 - (R_a / R_b)}{2}.$$



The parameters  $K$ ,  $\omega_n$ , and  $\zeta$  are defined as: static gain, damping ratio, and the natural frequency respectively. As can be seen from equation (1), the transfer function can only be determined if these three parameters are known.

For this specific case the following values of the circuit's components are considered:  $R = R_a = R_b = 10\text{K}\Omega$ , and  $C = 10\text{nF}$ . Therefore, the theoretical transfer function is:

$$G_{th}(s) = \frac{10^8}{s^2 + 10^4 s + 10^8}$$

The objective of the experiment is to estimate the transfer function (TF) of the above circuit using both time and frequency responses. For this the appropriate parameters are measured on each response. These parameters are therefore used to determine the three main parameters, namely the static gain, the damping ratio, and the natural frequency of the second order TF.

### Hardware used for the Experiment

We have used two light weight inexpensive Electrical Engineering Laboratory Kits. The first one is the Digilent Electronics Explorer board (EE board) kit powered by a free, PC-based software. It includes Electrical Engineering Laboratory devices such as an oscilloscope, a waveform generator, a power supply, a voltmeter, a solderless breadboard and a reference voltage generator. Digital signals can also be configured as pattern generator, a logic analyzer, or any one of several static digital I/O devices [8]. Figure 6 shows the EE Board along with its main user interface enabling virtual access, and manipulation of the devices connected to the student computer. Figure 5 also shows, in the EE Board oscilloscope interface, the response time of the circuit under test to be described in the next session.

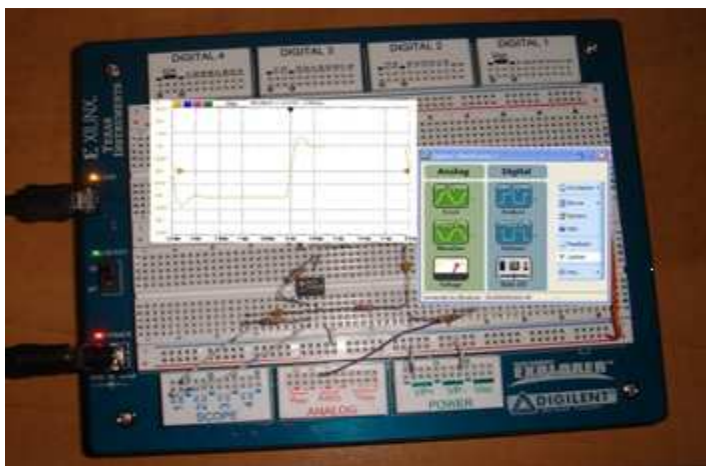

Figure 6 Digilent Electronics Explorer board (EE board) kit

The second kit we have used for the same experiment and scenario as with the EE Board, is the CircuitGear [9], an inexpensive Open Source software USB-Based Laboratory Instrument that includes, through a computer user interface, a scope and a function generator. The software associated with it allows to add features such as digital input/output, a vector network and a spectrum analyzer and a noise generation capability.

### **Our Experimental Scenario**

As can be seen in Figure 1, the scenario that we implemented involved three participants. At Site C, the teacher accesses, using DropBox and BigBlueButton software, the Cloud virtual environment described in the previous section. The teacher may or may not have CircuitGear of Syscomp or EEBoard of the Digilent devices. In our case, the teacher plays the role of laboratory work supervisor. He /She can monitor or give instructions in synchronous or asynchronous mode during all stages of completion of practical work carried out by two students from their homes, one with Digilent Inc. EEBoard device and the other with the CircuitGear, CGR-101 of Syscomp. At Site A, The CGR-101 device has a waveform generator, a two-channel oscilloscope, and a digital input-output port. In this experiment, the waveform generator is used to generate a symmetrical square waveform with amplitude 1 Volt and a frequency of order of 100 Hz. The generated waveform is then applied to the input of the circuit. The two channels of the oscilloscope are used for the acquisition of both the input and output signals of the circuit. The CGR-101 device is connected to the computer using an USB cable. An external power supply is used to feed the operational amplifier of the circuit under study which is mounted on an external breadboard. At Site B, another student carried out the same experiment but in this case, the EEBoard has its own power supply and breadboard as part of the device. In both cases, the data generated during the lab sessions are stored, shared and synchronized as shown in Figures 2 and 3.

### **Experimental results from time response**

Figure 7 shows the response time obtained on the graphical user interface of the CGR-101 device:

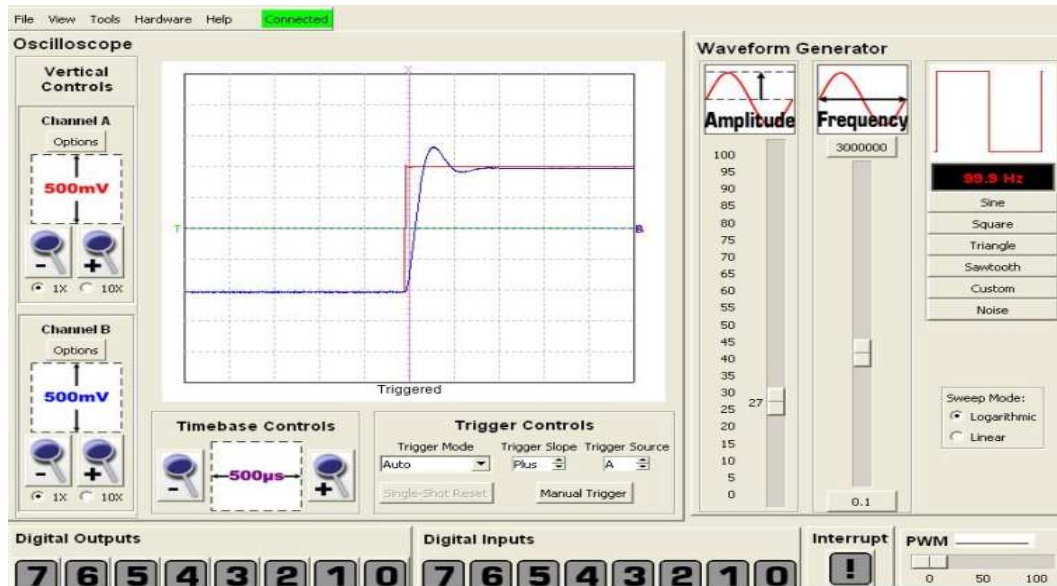

Figure 7 Response Time of the Circuit

Students use the data of this response to determine parameters which allow the determination of the three main parameters of the transfer function. Such parameters are shown in the following table:

Tref, µs	Tprel, µs	Vs,max, V	Vs,ss_init, V	Vs,ss, V	$\Delta V_e$
3968	4294,4	1,32	-1.036	0,97	2

In the above table:

- Tref is the reference time (the moment when the sign of the square wave change);
- Tprel is the relative peak time;
- Vs,max – maximal value of the output signal;
- Vs,ss - steady state value of the time response;
- Vs,ss\_init - initial steady state value of the time response;
- $\Delta V_e$  - input signal variation.

There are analytical relationships between the three main parameters of the TF and the measured values in the above table. For example the static gain can be determined from:

$$K = \frac{V_{s,ss} - V_{s,ss\_init}}{\Delta V_e}, \quad (2)$$

Using these relationships the following experimental transfer function is obtained:

$$G_{\text{exp}}(s) = \frac{1,211 \cdot 10^8}{s^2 + 1,0676 \cdot 10^4 s + 1,211 \cdot 10^8}$$

## Experimental results from frequency response

Figure 8 shows the frequency response obtained on the graphical user interface of the CGR-101 device:

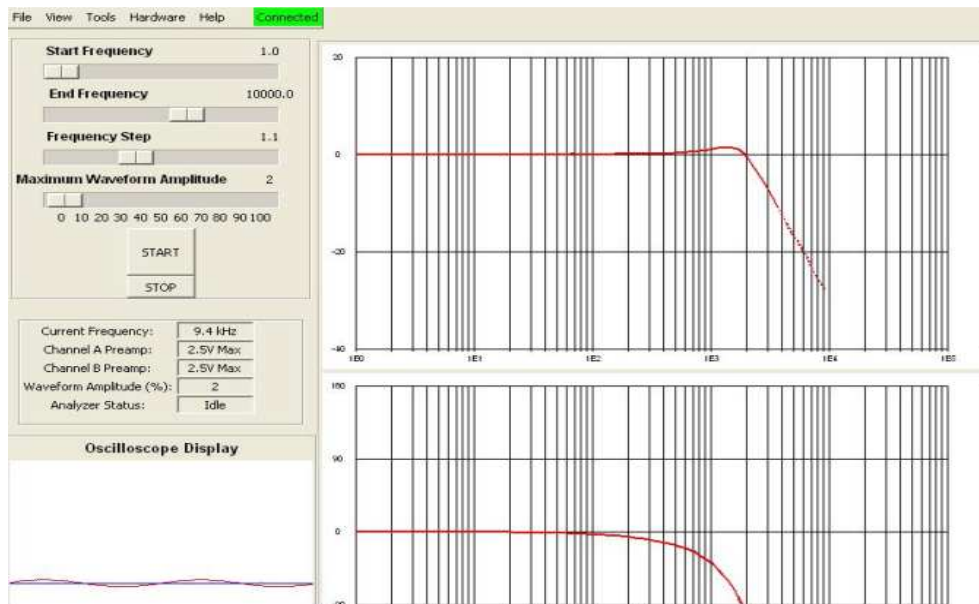

Figure 8 Bode diagram of the circuit

Again in this case students use the data of the obtained response to determine parameters which allow determining the three main parameters of the TF. These parameters are shown in the following table:

$G_{dc}$ , dB	$M_p$ , dB	$f_r$ , Hz
0,0856	1,4457	1539

In the above table:

$G_{dc}$  - the gain in low frequency;

$M_p$  - the maximum value of the amplitude diagram;

$f_r$  is the resonance frequency.

In this case also there are analytical relationships between the three main parameters of the TF and the measured values in the above table. For example the static gain can be determined from:

$$20 \log K = G_{dc} \quad (3)$$

The following experimental transfer function is obtained:

$$G_{\text{exp}}(s) = \frac{1,759 \cdot 10^8}{s^2 + 1,284 \cdot 10^4 s + 1,759 \cdot 10^8}$$

In terms of the laboratory work itself, the two different methods, namely the response time and the frequency response have been tested with both the CircuitGear (CGR-101) and the Digilent Inc. EEBoard. The comparison of the experimental results and

theoretical values shows that the method based on the response time is more precise than the one based on the frequency domain.

## Conclusion

For several years we advocated the concept of remote laboratories in all its facets including virtual laboratories and distributed interactive simulations. With the availability of portable and inexpensive equipment and that of computer applications easily reconfigurable and free in the Cloud, we are able to broaden the definition to include labs at a distance. The concept we propose in this article allows for better integration of sensor networks and mobile laboratories. Our future work in this direction would be to consider the application of the concept in other areas, as we did for the field of electrical engineering and perform validation on a larger scale. All issues relating to security in the cloud and all business models and scenarios will also be considered in the future.

## References

- [1] H. Saliah-Hassane, E. Nurse, A. Abecassis, "*Design of a Generic, Interactive, Virtual and Remote Electrical Engineering Laboratory*" *Proceedings of the 1999 Frontier in Education Conference 99: the Future of Science and Engineering Education*, San Juan Puerto Rico, November 10 – 13, 1999.
- [2] H. Saliah-Hassane, C. Loizeau, P. Dumont-Burnett, "*Design of a Web-Based Virtual Laboratory Instrument Measurement Interface*", dans W. Aung, P. Hicks, L. Scavarda, V. Roubicek, C. Wei (eds.) "*Engineering Education and Research 2001, A Chronicle of Worldwide Innovations*"; BEGELL HOUSE PUBLISHING, 2002, Chap. 13, pp.127-134
- [3] S. Kolberg, T. Fjeldly, "*Remote Educational Laboratory System Based on Web Services Standards*", in W. Aung, P. Hicks, L. Scavarda, V. Roubicek, C. Wei (eds.) "*Engineering Education and Research 2005, A Chronicle of Worldwide Innovations*"; BEGELL HOUSE PUBLISHING, 2005, Chap. 20, pp.119-131
- [4] J. Rittinghouse, J. Ransome, "*Cloud Computing: Implementation, Management, and Security*", 2010
- [5] BigBlueButton, <http://bigbluebutton.org/>
- [6] L. Villardier, H. H. Saliah, L. Sauvé, "*A Synchronous Collaborative Environment for Distance Education*", "*Proceedings of the International Conference on Information Technology Based Higher Education and Training ITHET 2003*"; Marrakech, Morocco, July 7-9, 2003
- [7] DropBox, <https://www.dropbox.com/>
- [8] Diligent Circuit EE Board, <http://diligentinc.com>
- [9] SYSCOMP, <http://www.syscompdesign.com/CGR101.html>
- [10] N. S. Nise, *Control Systems Engineering*, 5th edition, Wiley & Sons