



Utilizing Applications Programming Interfaces to Provide Product Lifecycle Management and Enhance Manufacturing Education

Dr. David E. Culler, Oregon Institute of Technology

Dr. Culler has an M.S. and Ph.D. from New Mexico State University in Industrial Engineering and over 20 years experience in using and developing Computer Aided Manufacturing (CAM) systems and teaching topics such as Product Data Management (PDM) and Product Lifecycle Management (PLM).

Noah David Anderson

Utilizing Applications Programming Interfaces to Provide Product Lifecycle Management and Enhance Manufacturing Education

Abstract

In the past 30 years, software development companies have made great strides in the areas of project planning, business management, material handling, engineering and manufacturing, in hopes that someday an all-in-one software package would be made available. Companies like PTC, Dassault Systèmes, AutoDesk and Siemens NX, are making this dream a reality.

Just because one very expensive piece of software can handle most aspects of engineering development that does not mean that it is flexible. Nor can it be adapted to individual companies and their standard practices. This gives companies the false hope of true integration, where the same information has to be entered multiple times, and no time is saved when working between modules. True integration occurs at the point where both customization and artificial intelligence meet, to produce an outcome that saves both time and money.

Through the use of API's (Application Programming Interface) and custom software, true integration is closer to becoming a reality. The focus of this project is to develop a customized software program geared toward small to mid-sized job-shop companies that cannot afford all-in-one software packages. Software like SolidWorks, FeatureCAM, and Microsoft Office, are commonly used by such companies and with the aid of API's, a software will have the ability to communicate directly to objects inside each program. In particular, this software will focus on the transition between design, engineering, and manufacturing and the information that is passed between each stage of development.

The results of this project demonstrate that the potential exists to enhance and simplify the product development process, but many questions remain unanswered and future technologies may help to unlock the key to full integration. For most mechanical engineering students, computer programming can be a challenging class. Due to the limited number of classes that engineers are required to take on the subject, programming is notoriously presented in a dry and non-enthusiastic way. However, through the use of API's, students can connect more easily with programming concepts because it would involve an additional subject that they are more familiar with like parametric modeling and CNC programming. The following article discusses a student project in which the student learned to use API's and was able to develop software to manage data for a small to midsize job-shop environment, namely the shop at Oregon Tech.

Introduction

Computer assisted product development takes advantage of technological advances in areas such as CAD/CAE/CAM, ERP (Enterprise Resource Planning), and PDM (Product Data Management). In addition, API's (Application Programming Interface) provide tools that from an applied research perspective that has the potential to achieve a level of integration that up to now has been unseen. Product development can be broken down into five basic steps: conception, design, engineering, manufacturing, and quality control. Fortunately, a large

company can invest enough money to have a separate department that represents each of these steps, while a small company generally cannot. It might seem efficient to have individual departments that specialize in each stage; however, what is usually neglected is the information that is necessary to pass a project to the next stage. The information that gets passed on is normally generic or minimal, and does not include much of the thought process from the person working at each step. To fill this void the information must be enriched without adding on extra work at each stage of the project.

The key would be to start from the conception stage by extracting and storing the information along the way. This information could reduce the number of times the same information is entered into different software packages, prepare different software with intuitive setup configurations, or output generic documentation. In addition, a centralized database could be developed so information is made available and distributed in different formats.

Background

The Engineering Design Process (EDP) and the steps involved in new product development have been studied and used for many years. What is not so clear or well documented in the literature is the influence that modern Computer Assisted Technologies (often referred to as CA'X') have changed how the process is accomplished by design and manufacturing engineers. One thing is clear, CAD/CAE/CAM systems play a crucial role in many phases of the process and form the foundation of integrated product development and data management (See Figure 1). Currently, there is a lot of work underway to define standards and develop tools that will impact how companies do business and how digital data will be stored and used throughout the process, between departments and even with partnering companies. International Standards such as the Standard for the Exchange of Product Data (STEP) are attempting to define exchange formats to help in this ongoing effort. [3]

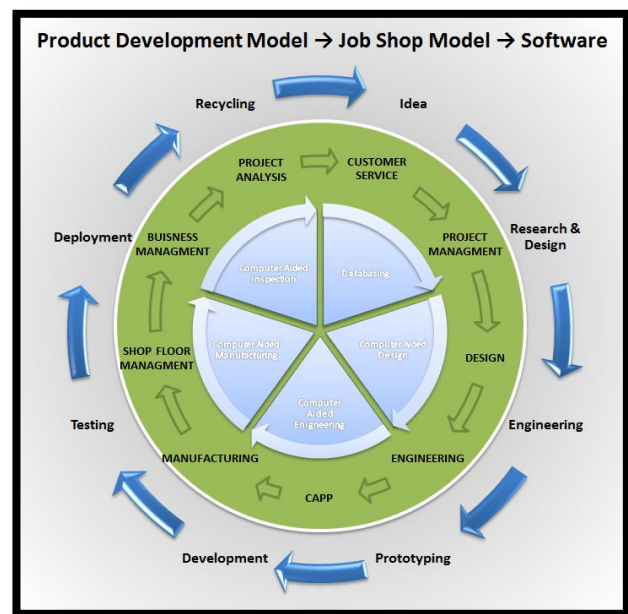

Figure 1: New Product Development Model

Although many new acronyms have been created in recent years to describe the allusive dream of *full integration*, Product Data Management (PDM) and Product Lifecycle Management (PLM) are two terms that are widely used in both academia and industry. For the purpose of the work done during this project and presented here, they provide a contextual platform to identify and study the issues and important aspects of what is currently being done and where these ideas might go in the future. For anyone who has attended a seminar or read a paper on PLM, it can be a challenge to walk away with a clear definition of exactly what it means and how it is applied, including the tangible benefits that it provides. A large part of this confusion is created by the

major CAD vendors and 3rd party commercial software programs that market and sell their products or add-on modules as “complete integrated solutions” to all your problems. The reality is that there are still many missing links and concepts that are not fully understood, as well as technologies and standards that are currently under development that will determine what the future holds for PDM and PLM.

Many works can be cited which have covered the areas of PLM, PDM, Computer Aided Process Planning (CAPP) and CAD/CAM integration. In addition, some 3rd party software programs provide insight into what is currently available in industry. Project GURU (GURU) has attempted to incorporate some of the ideas learned by reading papers and watching videos/webinars about this subject. While at the same time taking a completely new approach on how engineering, manufacturing and operations fit together. Some of the works that are most closely related to this project are summarized below. It is also worth noting that the project is based on previous work completed by Dr. David Culler and William Burd as is described in the RCIM Journal article titled “A Framework for Extending Computer Aided Process Planning to Include Business Activities and Computer Aided Design and Manufacturing (CAD/CAM) Data Retrieval”. [6]

Proposed System Development

The above mentioned ideas are what is behind the applied research project titled “Project GURU” that has been completed during the last one and a half years as part of the requirements for the MSMFG degree in the MMET department at OIT. The main objective of the project is to develop custom computer programs and Graphical User Interfaces (GUI’s) that demonstrate PLM within the context of a functioning job shop that uses modern 3D CAD/CAM systems. Within the scope of the main objective, three important goals have been identified:

- 1. Combine the model defined by the traditional engineering design process with the functionality of a shop floor management and control system to incorporate order entry and processing with CAD/CAE/CAM tools that are used for design, analysis and NC programming.*
- 2. Demonstrate how Application Programming Interfaces (API’s) available in many software programs, including CAD/CAE/CAM provide the “missing link” to automating repetitive tasks, connecting different stages of the product development cycle and extracting information from the proprietary databases so that it can be organized and distributed efficiently.*
- 3. Show the benefits and level of integration that can be achieved by applying the Project GURU software to a typical mechanical component such as an aluminum adaptor plate. The final demonstration will introduce the part into the system as an order, go through the CAD and CAE work in SolidWorks, move into FeatureCAM for CNC programming and finally to the 3-Axis Cincinnati Arrow 1000 milling center for production. The MS Excel and Outlook programs and their role will also be shown.*

Program Description

By creating a VB-NET shell, where order entry and resource management activities take place and where commercial software programs are opened and closed, The software developed for this project which was called “GURU” has the ability to collect and manage data by monitoring the progress of an order/part as it advances through the process described earlier in Figure 1.

The shell is linked to the other programs through the Microsoft object libraries available in software such as Excel, SolidWorks and FeatureCAM to mention a few examples.

The tools developed for this project focus on configuring, automating and exchanging data throughout the product development and order processing stages incorporated in GURU. This represents a key point to customizing or “fitting” the software for the capability, resources and product lines of a particular company. By doing this, it is possible to tailor the software to many different product manufacturing environments or companies. In the future, as software technology continues to advance, the CAD/CAE/CAM components could be interchanged based on the preferred systems of the end-user.

If you take a look at any particular engineering project, regardless of size, there is a copious amount of information that is accrued from start to finish. For example, documents such as customer information, quotes, design notes, technical drawings, process plans and more is just some of the pieces that are stored along the way. Through the advancements of GURU, information can flow seamlessly to the appropriate users, with less repetition. This software is customer based, so once a customer enters the system, everything pertaining to that customer stays with them, contact information, quotes, project data, etc. In order to access information about a project, a user will begin by identifying the customer and then the specific project they are working on for that customer. As a project progresses through the system, information is collected, so it can be used again to save time (See Figure 2).

Through the use of user login privileges, GURU can be accessible from everyone’s computer work station, from the front desk secretary, to the engineers, the shop floor, and even upper

management. A manufacturing engineer will be able to login and have access to the technical drawings but cannot change the original engineered model; while a manager will have access to customer databases and project analysis, but will not have access to shop floor data or CAD model revision.



Figure 2: Transitional Data

Project GURU is designed around the customer which can be derived from the product lifecycle development model. One of the first phases in developing this software was to create the Graphic User Interface (GUI), which had to be user friendly. When choosing the main style of interface, the ribbon panel is one of the more common styles that is used in today's modern software. The ribbon panel groups common tools and commands in a chronological order. The user is initially presented with the panel that has all the common tools for the first step and is followed by the next panel to accomplish the next step of the process and so on. Project GURU utilizes the ribbon in a very organized sequence, where each panel represents a process step. (See Figure 3).

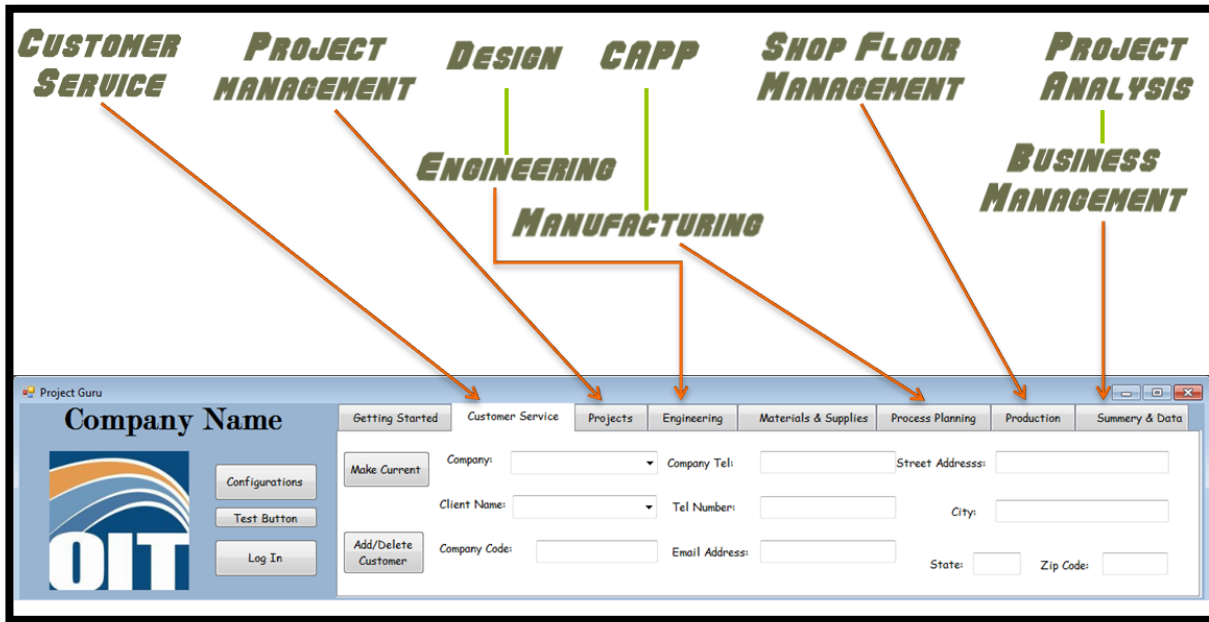

Figure 3: GURU Main Interface Breakdown

The next consideration, when creating GURU's GUI, was deciding how the user was going to interact with the software. One unique characteristic about this software is that it interacts with a separate CAD/CAM software along with Microsoft Office. The user needs to be able to interact with two or three software's at once without too much confusion. Screen real estate is a high commodity on an engineer's work station, so the idea came to mind that the main GUI would just occupy the ribbon panel at the top of the user's computer. Then, to take it one step further, the ribbon collapses to reveal the maximum available screen space, while still having Project GURU a quick click away.

Not every function of Project GURU could be handled through the ribbon panel, so a second user form was created to allow for additional user interaction. For example, the appearance of the software is customizable to some extent based on the company that is using it. So this additional user form is used for configuring the software. This may include things like the company name and logo, as well as shop equipment, etc.

During the development of Project GURU, modularity took a high priority with both the GUI and the coding. If the GUI was modular it made the code modular based on the fact that in most

cases the code resided in the class for that GUI. Aside from the ribbon and the tab pages used in GURU, separate panel forms were created for each page of the ribbon. Now, remember each panel represents a step or stage in the product development cycle and since the panels are modular and the codes stays with the panel, so a new or updated panel can easily take its place if necessary. Also, project GURU needs to interact with CAD, CAM software, and being that there are so many different software packages out there, a different panel can be created to interact with different software packages. Project Guru was built with SolidWorks and FeatureCAM so the Engineering panel has the code behind it to communicate with SolidWorks, while the Process Planning panel has the code to communicate with FeatureCAM. However, not every job shop will have SolidWorks, so if they have Autodesk Inventor for example, a new panel could be custom made to take the place of the SolidWorks panel. The necessary API programs would have to be developed to replicate the functionality currently provided by SolidWorks.

System Architecture and Application

API's play a significant role in project GURU, enabling the manipulation of other software programs without them physically being opened or operated. An API is a set tools made available by software developers to allow users to write small programs/macros that interact directly with the software. These tools are based on rules and definitions that relate to different objects in the software. API's are created around object oriented programming, which is based on the hierarchy of an object, its property, and the method to control object properties.

API's were developed early on as a crude tool to allow developers to automate repetitive tasks easily. Eventually, these tasks were adopted by the software company as new tools or modules that get built into the overall software program. Software companies saw this as a benefit, by getting feedback from their customer through macros, a custom written small program, which utilized the API. This encouraged software companies to invest time in developing more extensive API libraries that would allow for more creative results.

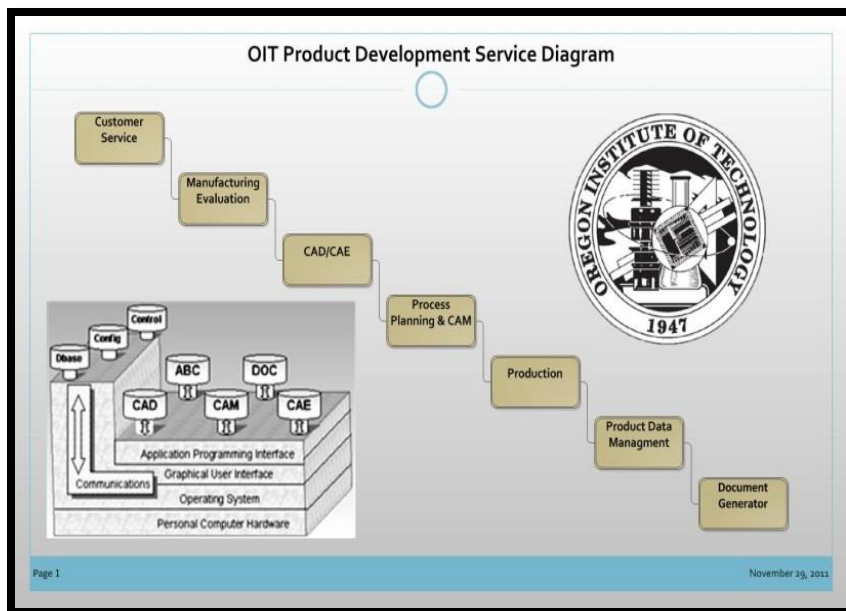

The software produced during this project will take advantage of the API's available in SolidWorks, FeatureCAM and Windows to demonstrate the flow of information that is created during the quotation and evaluation, design, process planning of components using CAD/CAE/CAM systems. To fully demonstrate the capability of this system, OIT's machine shop is being used as a model. Above, Figure 4 describes the flow of

Figure 4: PC Software Architecture

processes used in a job shop setting as well as a diagram that represents the software architecture built on a personal computer. The goal is to tie together pieces of the process so that automated data management can take place.

Results and Sample Part

To demonstrate the concepts and versatility of Project GURU, an adaptor plate for a jet engine is being used (See Figure 5). This adaptor plate is a critical component of the jet engine because it both supports the weight and thrust of the engine while allowing coolant and fuel to flow through it.

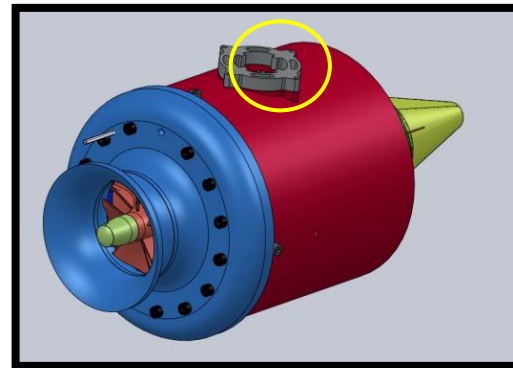

Figure 5: Jet Engine Adaptor Plate

Oregon Institute of Technology 3201 Campus Dr. Klamath Falls, Or. 97601 Telephone: 1-800-422-2017 Fax: 541-885-1024			
QUOTE			
Customer Company ACME Propulsion Department Mechanical Engineering Name Sam Frederick Telephone 831 422 3513 Fax 831 422 4516		Date 3/19/2012 Priority 2 Order # 1 Quote # 1	
Quantity	DESCRIPTION	PRICE / UNIT	TOTAL
1	Adaptor Plate Price includes material, screws and gaskets addition to ensuring compliance with the specifications	\$1,500	\$1,500
1	Material	\$60	\$60
		SUB-TOTAL	\$1,560
		Tax	0
		TOTAL	\$1,560
Delivery Time: Three Weeks Duration: 30 Days Shipping: Pickup Comments: Payment: Dollars			
Noah Anderson Customer Service Representative			
Date: March 10-2012, Tel/Fax: 885-1420 / 885-0000			

Figure 6: GURU Quote

Upon the quote being approved, an Engineer will be notified and the next stage, Engineering, will begin. Here an Engineer will start with either a supplied model given by the client or with a new model that is generated using GURU. Once a model is designed in SolidWorks, a Finite Element Analysis (FEA) is performed, as specified by the client, and the results are stored and readily available in GURU. Then a 2D technical drawing is created for manufacturing, where notes are extracted from the drawing and compiled for the NC programmer to read (See Figure 7).

The adaptor plate begins its journey through GURU at the Customer Service stage, where information about the company and client is entered into the system. Next at the Project Stage, a job is created in the quoting process. Here a designer sits down with the client and talks about the functionality of the component to get an idea of tolerances, materials and surface finishes, etc. During this stage, GURU will interactively step the designer through this interview by prompting questions, building a preliminary process plan and eventually producing a quote (See Figure 6).

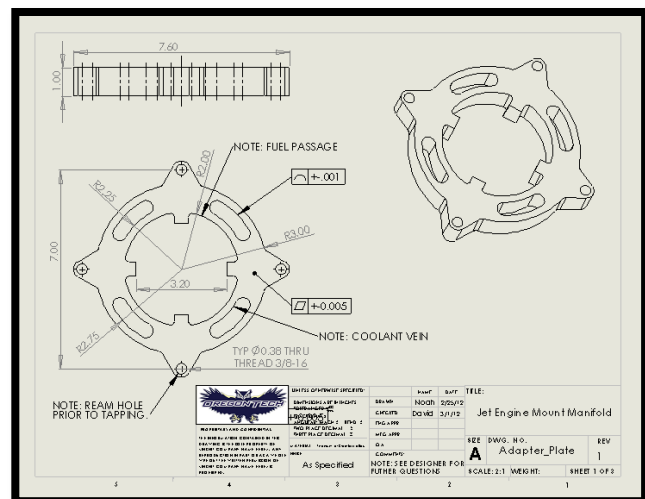

Figure 7: GURU Technical Drawing

Finally all the design information needs to be released, and the engineer has access to quickly output a batch of different files either through email or to a file location. Next the Manufacturing Engineer receives the 2D technical drawing and begins the Process Planning stage by reviewing the job in EDrawings (a 3D model/2D viewer). Here, notes are made in preparation for NC programming; these notes include setup locations, fixturing, tools, and material requirements, etc. Before moving to CAM, the manufacturing engineer has the ability in GURU to select different material geometry, round vs. square, to see which choice would have the least amount of recycled material. Next, a refined process plan, using the quote, is produced with a quick interactive guide in GURU. Finally, the NC programming begins, here GURU allows the programmer to quickly access common configurations like Machine Configuration, Tool Library's, Post Processor, etc. Then the part is automatically brought into FeatureCAM, where CAM notes, made previously, are available for the user to more efficiently begin creating features for the part. Finally, GURU automatically extracts the operations list to produce documentation for the shop floor (Figure 8).

Figure 8: Operations List

When the part is ready to be produced, the Production stage of Project GURU begins. Here shop floor data is monitored in real time for scheduling purposes. If the client is curious on the status of their job, with a quick call, a secretary is able to tell them where the part is on the shop floor and approximately how much longer it will take until it is ready to be picked up (See Figure 9). The Last stage of GURU, Summary and Data, plays a big role at the end of a job, where it

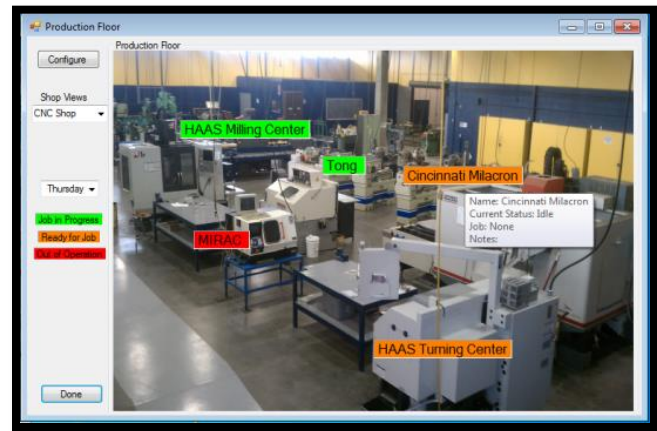

Figure 9: GURU Production Floor

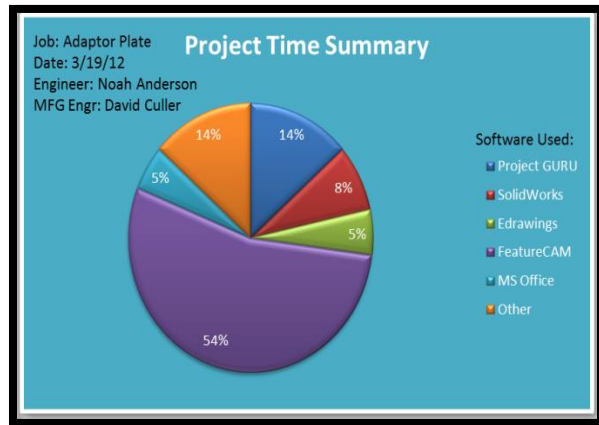

Figure 10: GURU Project Time Analysis

takes information from each stage of the job and produces statistics, times, efficiencies, and can identify where money was lost or gained. This is more of the business side to GURU for managers to analyze data after or during each job. Another function that GURU has, is its ability to monitor the computer work station of each employee and record the time spent at each stage of the job or the time spent in SolidWorks or FeatureCAM (See Figure 10).

Conclusions

All of the major CAD vendors have their own software modules to handle what they consider to be PLM. For example, Pro Engineer has Windchill, SolidWorks has Enterprise PDM, and Inventor has the VAULT; where each module shares most of the same functionality but with their own unique twist. Being that PLM is somewhat of a catch-phrase for basically managing data throughout the life of a product, it is open to interpretation. In the case of all three of these vendors they are based around the same concept of organizing model data through a hierarchy of files that represents an entire project. Additionally they can perform functions such as revision control and user login privileges. However, each of these software modules are trying to enrich the information that goes along with a project by gathering batch files, documentation, or any extra data that does not come from a CAD system. In order to stay competitive, the key is to become more customizable based on a company's needs and existing software.

The benefits of improving and using this system in the educational environment (especially for manufacturing engineers) is that it gives them a sense of how the business side of a company has to be connected to design, planning and production. Orders come in from customers and resources are applied (labor, tooling, materials, software, know-how) to meet the specifications and requirements. This takes an engineer that is dynamic, skilled in multiple areas, has good relationships with other departments/personnel and can carry a job through from start to finish. If that engineer also has a skill-set related to computer programming, user interfaces and interconnection between software programs through API's, then he/she can contribute even further by addressing critical bottlenecks and identifying opportunities to use software tools for improving efficiency, avoid duplicate data input and create templates and reports that will be useful to improving communication both inside and outside the company's walls.

References

- [1] Ahmad, Nafis, Anwarul Haque AFM, Hasin AA. *Current trends in computer aided process planning. Proceedings of the seventh annual paper meet and 2nd international conference, The Institution of Engineers, Bangladesh, Mechanical Engineering Division 25–27. Paper No. 10; 2001. p. 81–92.*
- [2] McMahon, Chris, Browne, Jimmie. *CAD/CAM: principles, practice and manufacturing management. Reading, MA: Addison-Wesley; 1998. p. 314–5.*
- [3] DRM Associates. CAPP, [Online] 2003 [cited 2004, Dec.10]; accessed on: URL: /<http://www.npd-solutions.com/index.html>.
- [4] Shen W, Nore D. *Multi-agent systems for concurrent design and manufacturing. London: Taylor and Francis Publishing Co.; 2001.*
- [5] Cecil J, Rodriguez C. *An internet based approach to support distributed product development. Proceedings of the annual IIE research conference, Portland, Oregon, 2003 May 17–21.*
- [6] Shaw C, Feng. *Preliminary design and manufacturing planning integration using web-based intelligent agents. J Intelligent Manuf, 2005;16:423–37.*
- [7] Roztock, Narcyz, Valenzuela Jorge F. *A procedure for smooth implementation of activity based costing in small companies [Online] 2001 [cited 2004, Nov. 10]; accessed on: URL: /<http://www.pitt.edu/~roztock/abc/abc.htm>.*